

ASSEMBLY AND INSTALLATION INSTRUCTIONS

W0357

WARNING: TO AVOID RISK OF ELECTRICAL SHOCK, BE SURE TO SHUT OFF POWER WHILE INSTALLING OR SERVICING THIS FIXTURE.

NOTES: 1. Before installing, consult local electrical codes for wiring and grounding requirements.
2. Read and save these instructions.

Hardware Package (included):

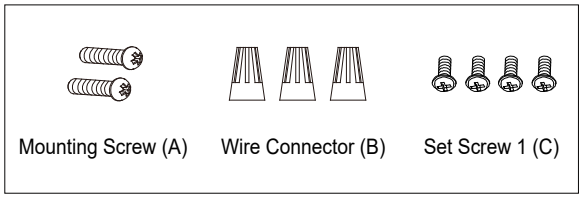

Mounting Screw (A) Wire Connector (B) Set Screw 1 (C)

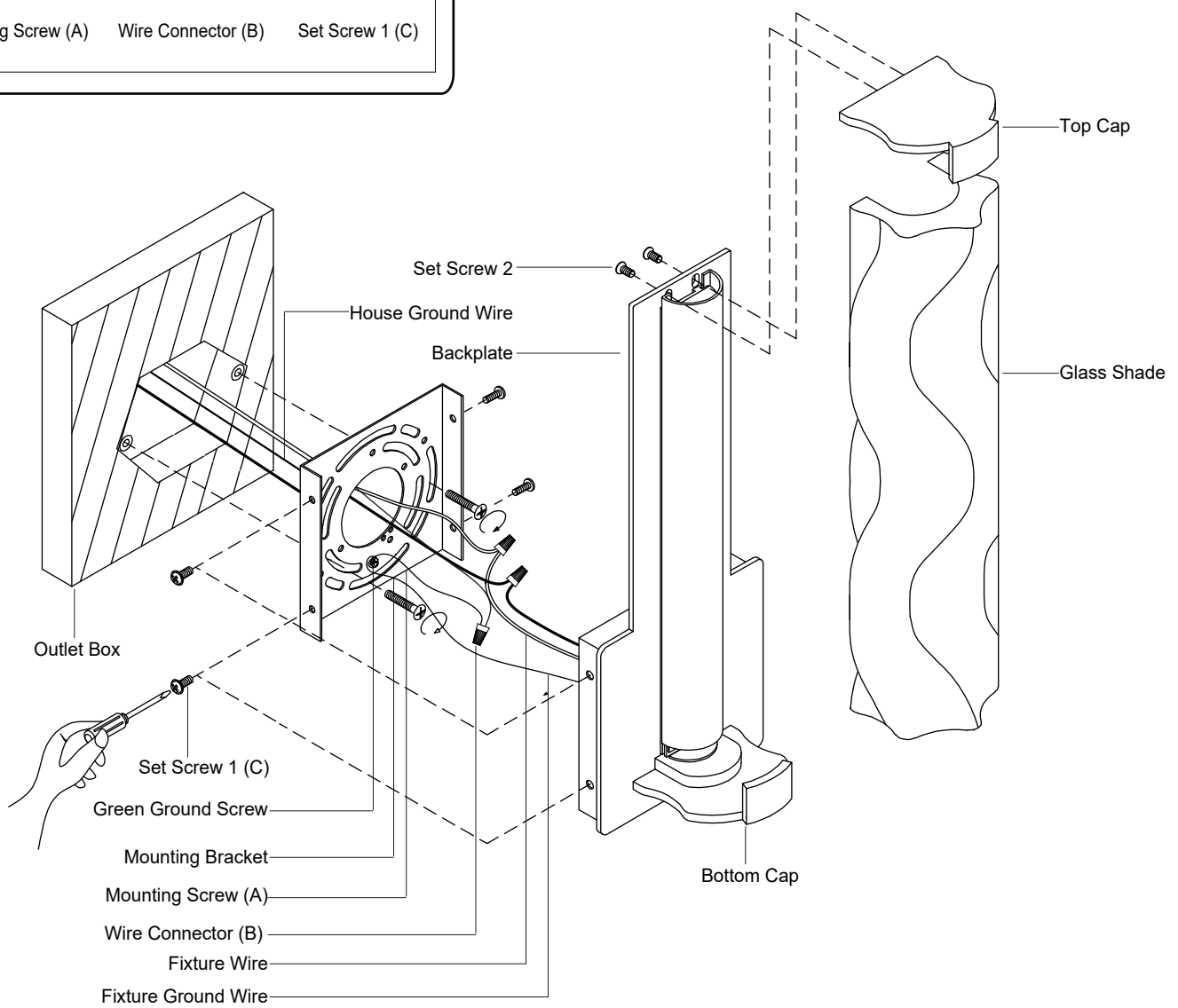

Installation Steps

Turn off the power at fuse or circuit box.



1. Put the glass shade on the bottom cap and make sure the glass shade is fixed properly.
2. Secure the top cap to the backplate with two set screws 2.
3. Attach mounting bracket to the outlet box using two mounting screws (A).
4. Pull out the source wires from the outlet box. Make wire connections using wire connectors (B) as follows:
 - Connect the hot wire (black insulation) from the power source to the black wire from the fixture.
 - Connect the neutral wire (white insulation) from the power source to the white wire from the fixture.
 - Attach the fixture ground wire (bare wire) to the mounting bracket with the green ground screw, or connect to the source ground wire if available.Carefully put the wires back into the outlet box.
5. Attach the backplate with the glass shade to the mounting bracket, then secure it with four set screws 1 (C).

Turn on the power at fuse or circuit box.

Note: Suggested dimmers are Lutron: MACL-153MH, DVWCL-153PH, TGCL-153PH, SCL-153P.

The following parts are available for re-order if damaged or missing.

Spare Parts List:

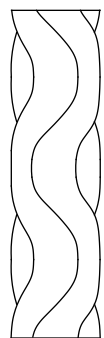
			← Assembly Kit 6194MM (1 SET)	
Mounting Screw (A)	Wire Connector (B)	Set Screw 1 (C)		

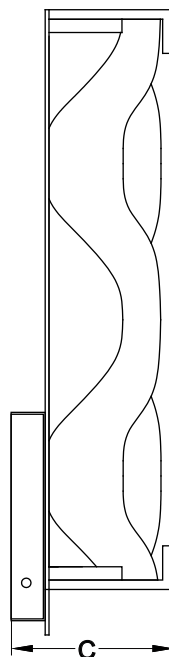
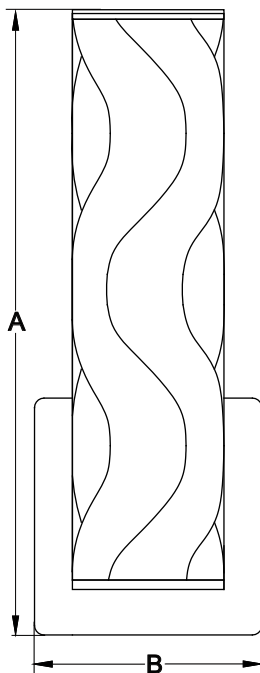

A: 13"

B: 4-3/4"

C: 3-1/2"